

POLOLU QTRX-HD-04A REFLECTANCE SENSOR

ARRAY

USER'S GUIDE

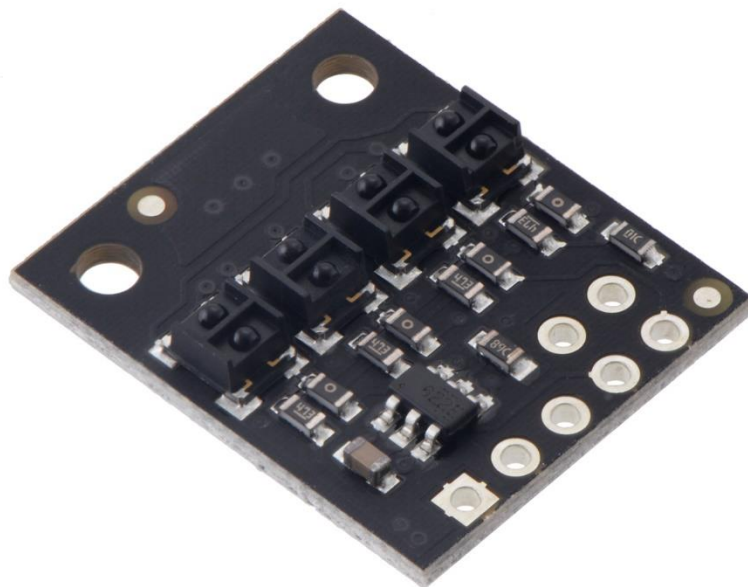

OVERVIEW

These reflectance sensors feature a linear array of IR emitter/phototransistor pair modules in a high-density (4 mm pitch) arrangement, which makes them well suited for applications that require precise detection of changes in contrast, such as line sensing. A variety of sensor counts are available so you can pick the ideal length for your application.

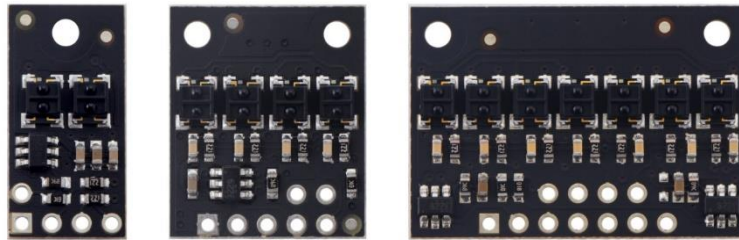

Unlike our original QTR sensor modules, these units have integrated LED drivers that provide brightness control independent of the supply voltage, which can be anywhere from 2.9 V to 5.5 V, while enabling optional dimming to any of 32 possible brightness settings. For modules with five or more sensors, there are separate controls for the odd-numbered and even-numbered LEDs, which gives you extra options for detecting light reflected at various angles. See the “Emitter control” section below for more information on using this feature.

Two different sensor options are available, denoted by “QTR” or “QTRX” in the product name. The “QTR” versions feature lower-cost sensor modules without lenses while the “QTRX” versions feature higher-performance sensor modules with lenses, which allow similar performance at a much lower IR LED current. You can see the two different sensor styles in the pictures below of the 4-channel modules:



QTR-HD-04A Reflectance Sensor Array.

QTRX-HD-04RC Reflectance Sensor Array.

Each sensor option is available in two output types: an “A” version with analog voltage outputs between 0 V and VCC, and an “RC” version with outputs that can be read with a digital I/O line on a microcontroller by first setting the lines high and then releasing them and timing how long it takes them to read as low (typically anywhere from a few microseconds to a few milliseconds). The lower the output voltage or shorter the voltage decay time, the higher the reflectance. The following simplified schematic diagrams show the circuits for the individual channels:

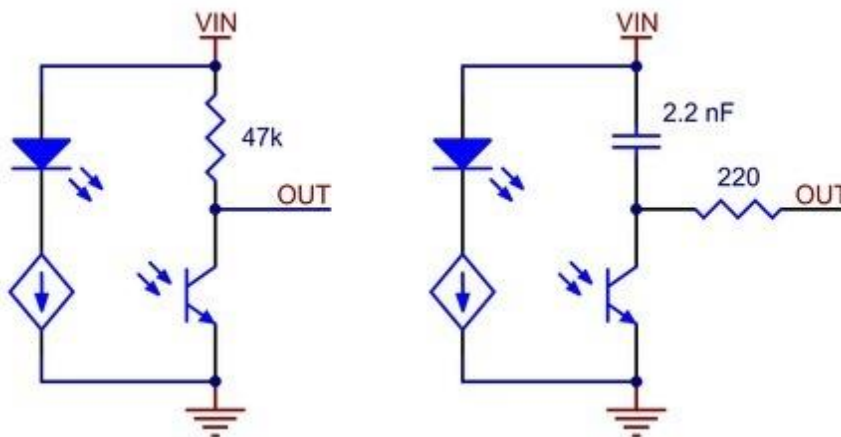

Schematic diagrams of individual QTR HD sensor channels for A version (left) and RC version (right).

INTERFACING WITH THE OUTPUTS OF THE A VERSIONS

Each sensor on the A versions outputs its reflectance measurement as an analog voltage that can range from 0 V when the reflectance is very strong to VCC when the reflectance is very weak. The typical sequence for reading a sensor is:

- Use a microcontroller's analog-to-digital converter (ADC) to measure the voltages.
- Use a comparator with an adjustable threshold to convert each analog voltage into a digital (i.e. black/white) signal that can be read by the digital I/O line of a microcontroller.
- Connect each output directly to a digital I/O line of a microcontroller and rely upon its logic threshold.

This last method will work if you are able to get high reflectance from your white surface as depicted in the left image, but will probably fail if you have a lower-reflectance signal profile like the one on the right.

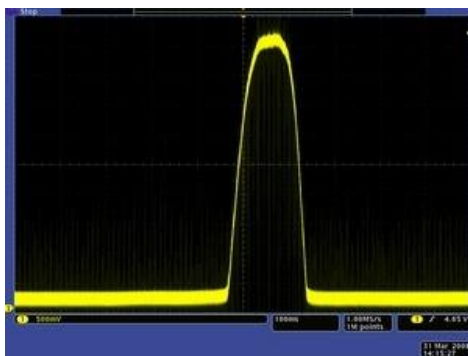

QTR-1A output 1/8" away from a spinning white disk with a black line on it.

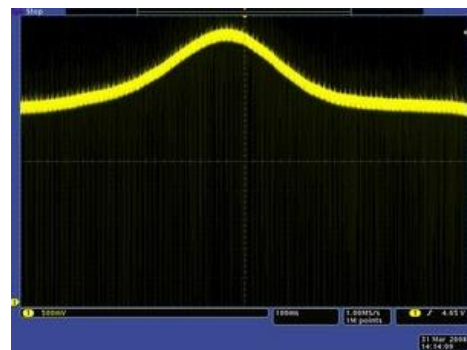

QTR-1A output 3/8" away from a spinning white disk with a black line on it.

INTERFACING WITH THE OUTPUTS OF THE RC VERSIONS

Each sensor on the RC versions requires a digital I/O line capable of driving the output line high and then measuring the time for the output voltage to decay. The typical sequence for reading a sensor is:

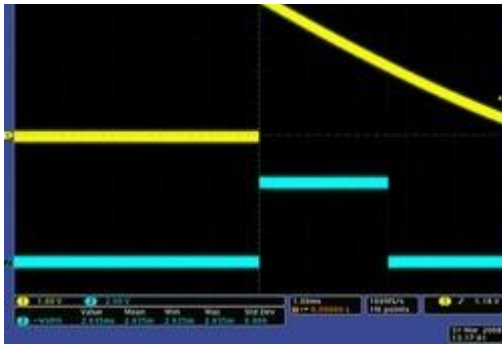

QTR-1RC output (yellow) when 1/8" above a black line and microcontroller timing of that output (blue).

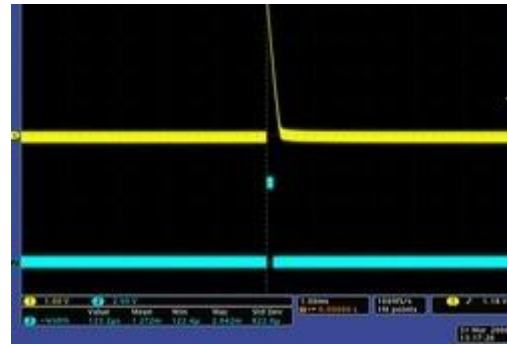

QTR-1RC output (yellow) when 1/8" above a white surface and microcontroller timing of that output (blue).

1. Turn on IR LEDs (optional).
2. Set the I/O line to an output and drive it high.
3. Allow at least 10 μ s for the sensor output to rise.
4. Make the I/O line an input (high impedance).
5. Measure the time for the voltage to decay by waiting for the I/O line to go low.
6. Turn off IR LEDs (optional).

These steps can typically be executed in parallel on multiple I/O lines.

With a strong reflectance, the decay time can be as low as a few microseconds; with no reflectance, the decay time can be up to a few milliseconds. The exact time of the decay depends on your microcontroller's I/O line characteristics. Meaningful results can be available within 1 ms in typical cases (i.e. when not trying to measure subtle differences in low-reflectance scenarios), allowing up to 1 kHz sampling of all sensors. If lower-

frequency sampling is sufficient, you can achieve substantial power savings by turning off the LEDs. For example, if a 100 Hz sampling rate is acceptable, the LEDs can be off 90% of the time, lowering average current consumption from 125 mA to 13 mA.

EMITTER CONTROL

These reflectance sensor arrays maintain a constant current through their IR emitters, keeping the emitters' brightness constant, independent of the supply voltage (2.9 V to 5.5 V). The emitters can be controlled with the board's CTRL pins. Units with 5 or more sensors have two emitter control pins: CTRL ODD and CTRL EVEN. By default, these are connected together with a 1 k Ω resistor and pulled up, turning on all the emitters by default and allowing them to be controlled with a signal on either pin, but the CTRL ODD and CTRL EVEN pins can be driven separately for independent control of the odd-numbered and even-numbered emitters. Units with 4 or fewer sensors have a single CTRL pin that controls all of the emitters.

Driving a CTRL pin low for at least 1 ms turns off the associated emitter LEDs, while driving it high (or allowing the board to pull it high) turns on the emitters with the board's default (full) current, which is **30 mA** for "QTR" versions and **3.5 mA** for "QTRX" versions. For more advanced use, the CTRL pin can be pulsed low to cycle the associated emitters through 32 dimming levels.

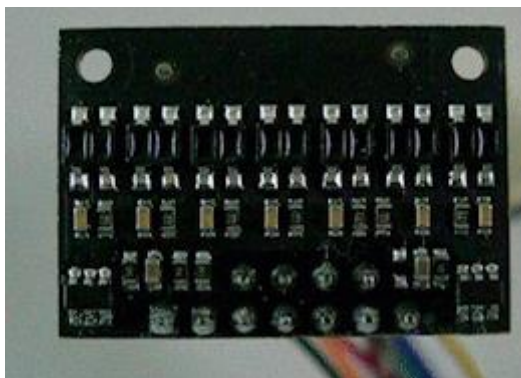

Demo of IR LED dimming and independent even/odd control on the QTR-HD-07x (as seen through an old digital camera that can see IR).

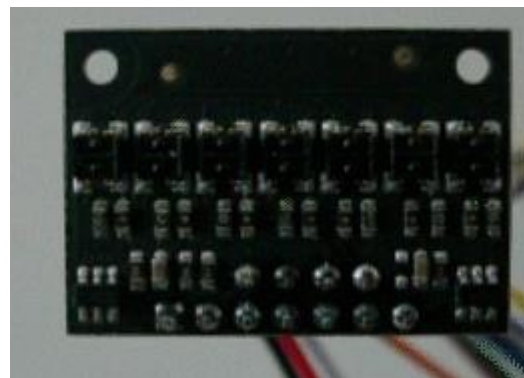

Demo of IR LED dimming and independent even/odd control on the QTRX-HD-07x (as seen through an old digital camera that can see IR).

To send a pulse, you should drive the CTRL pin low for at least 0.5 μ s (but no more than 300 μ s), then high for at least 0.5 μ s; (it should remain high after the last pulse). Each pulse causes the driver to advance to the next dimming level, wrapping around to 100% after the lowest-current level. Each dimming level corresponds to a 3.33% reduction in current, except for the last three levels, which represent a 1.67% reduction, as shown in the table below. Note that turning the LEDs off with a >1 ms pulse and then back on resets them to full current.

Dimming level (pulses)	Emitter current (%)	Dimming level (pulses)	Emitter current (%)
0	100.00%	16	46.67%
1	96.67%	17	43.33%
2	93.33%	18	40.00%
3	90.00%	19	36.67%
4	86.67%	20	33.33%
5	83.33%	21	30.00%
6	80.00%	22	26.67%
7	76.67%	23	23.33%
8	73.33%	24	20.00%
9	70.00%	25	16.67%
10	66.67%	26	13.33%
11	63.33%	27	10.00%
12	60.00%	28	6.67%
13	56.67%	29	5.00%
14	53.33%	30	3.33%
15	50.00%	31	1.67%

For example, to reduce the emitter current to 50%, you would apply 15 low pulses to the CTRL pin and then keep it high after the last pulse.