

ISO9001:2015 Quality certification

Customer			
keyword	M series,medical grade,7 inch,1024*600,with configuration, LUA script,audio,case		
Model	DC10600KM070_1111_XX(T/C),6P38 vertical		
Signature of Customer		Signature of Engineer	
Date		Date	

Content

1. Introduction of Hardware.....	1
1.1 Product Appearance.....	1
1.2 Hardware Configuration.....	1
1.3 Debugging Tools.....	2
2. Installation Diagram.....	4
3. Product Specification.....	5
4. Reliability Test.....	8
4.1 ESD Test.....	8
4.1.1 Executive Standard.....	8
4.1.2 Test Ambient.....	8
4.1.3 Test Data.....	9
4.2 High and low temperature aging test.....	9
4.2.1 Test Ambient.....	9
4.2.2 Test Data.....	10
4.3 Group Pulse Test.....	10
4.3.1 Executive Standard.....	10
4.3.2 Test Ambient.....	10
4.3.3 Test Data.....	11
4.4 Radiation Test.....	11
4.4.1 Executive Standard.....	11
4.4.2 Test ambient.....	11
4.4.3 Test Data.....	12
5. Product demension.....	14
6. Model definition.....	15
7. Switch RS232 & TTL electrical level.....	16
8. Protocol Configuration.....	17
9. LUA Script Configuration.....	19
10. Package and Size.....	21
11. Product Structure.....	22
12. Development Software.....	23
12.1 What is visual serial interface screen.....	24
12.2 The binding debugging of Keli and Virtual serial port screen.....	24
13. Development File.....	26
14. Disclaimer.....	27

1. Introduction of Hardware

This chapter mainly introduces some appearance reference diagrams, hardware configuration diagrams and debugging tools diagrams.

1.1 Product Appearance

Below are appearance reference diagrams of different model product in the same size, as Diagram 1-1, Diagram 1-2 showed.

Note: If there is no structural process modification, hardware reliability change or layout change, the company will not notify the customer, the standard is base on the product you received.



Diagram 1-1 7.0 inch resistive touch reference diagram



Diagram 1-2 7.0 inch capacitive touch reference diagram

1.2 Hardware Configuration

Below is the hardware configuration diagram of the 7 inch capacitive product, as Diagram 1-3 showed.

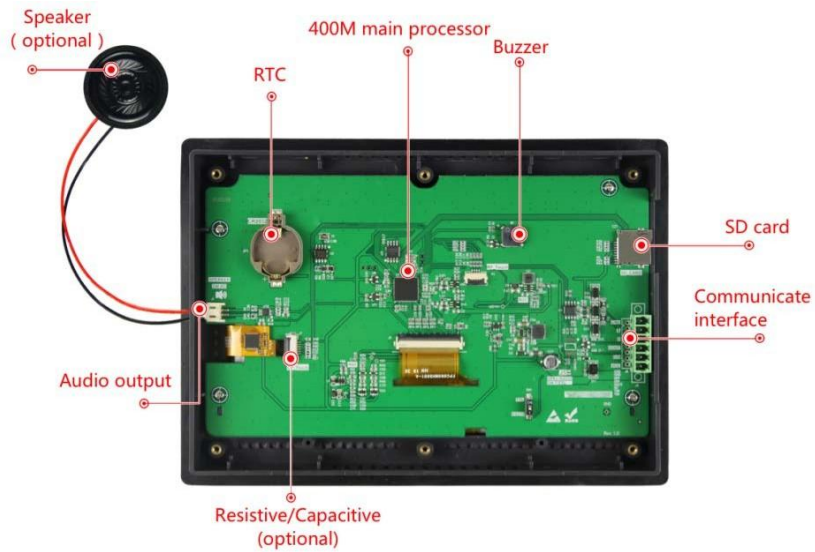

Diagram 1-3 for hardware configuration

1.3 Debugging Tools

Below is the debugging tool diagram of the capacitive product, as Diagram 1-4, Diagram 1-5 showed.

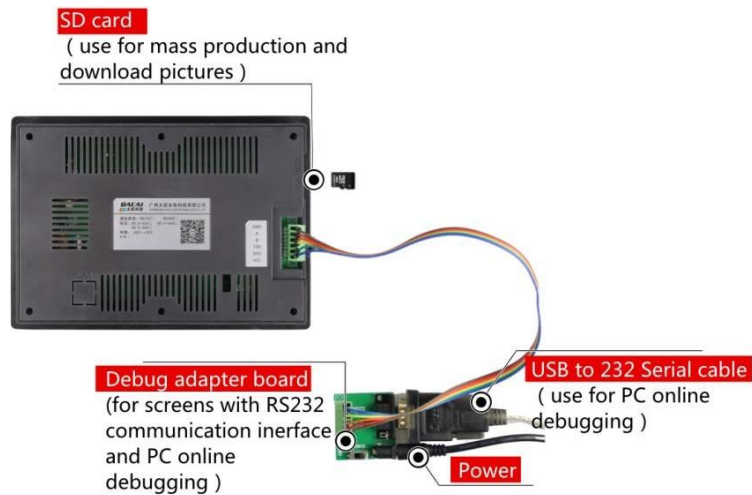

Diagram 1-4 for RS232 debugging tools

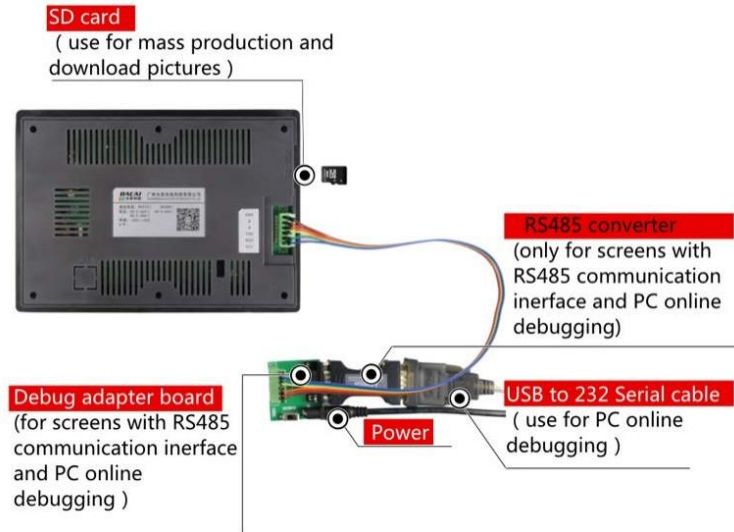

Diagram 1-5 for RS485 debugging tools

2. Installation Diagram

The following is the installation diagram of this model product.

外壳系列安装示意图

(THE SHELL SERIES INSTALLATION SCHEMATIC DIAGRAM)



第一步：如上图所示，将串口屏嵌入到客户机柜

(THE FIRST STEP: AS SHOWN IN THE ABOVE, TO EMBED THE SERIAL INTERFACE SCREEN CUSTOMER RACKS)

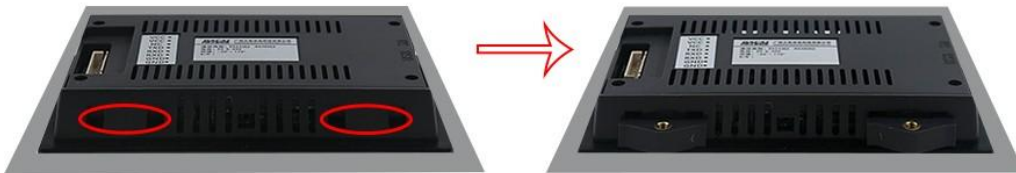

第二步：将卡扣插入如图红色标识位置的安装孔中

(STEP 2: INSERT THE CLASP INTO THE MOUNTING HOLE IN THE RED MARKING POSITION.)



第三步：旋紧螺丝，固定串口屏到客户机柜上

(STEP 3: TIGHTEN THE SCREWS AND SET THE SERIAL PORT TO THE CLIENT CABINET.)

Diagram 2-1 Installation diagram

3. Product Specification

◆ Product Specification	
Model Description	DC10600KM070_1111_0T,6P38 vertical (RS232/TTL,resistive touch) DC10600KM070_1111_0C ,6P38 vertical (RS232/TTL,capacitive touch) DC10600KM070_1111_4T,6P38 vertical (RS485, resistive touch) DC10600KM070_1111_4C,6P38 vertical (RS485, capacitive touch)
Product Series	Mseries,Medical grade
Core Processor	400M SOC processor
Operating System	No operating system (OS),can run once power on
Protocol Type	Default Dacai configuration instruction set, the host computer can be configured to run MODBUS RTU, XGUS protocol
Script language	LUA script, The screen can run user-written logic, protocol and algorithm functions
Size	7 inch
Resolution	1024*600
Installation Display	Support 0°/90°/180°/270°rotate display
Memory space	128Mbit
Font Library	Built-in vector font,edge anti-aliasing,including ASCII,GBK,GB2312 and UNICODE(Global language) libraries.Customized computer font display
Image Storage	Support JPEG,PNG (semi-transparent / full transparent) image,support for any size image storage. Accumulate to store about 115 full-screen images (calculated by size 120KB/frame,BMP format is not recommended).The image compression ratio is different,this value will float up and down.
Color	65K color, 16-bit RGB
Voltage	4.5-30V
Power Consumption	Darkest backlight non-speaker:0.7W
	Darkest backlight with speaker:1.6W
	Brightest backlight non-speaker: 2.2W
	Brightest backlight with speaker:3.3W
Communicate Interface	RS232/TTL(Factory default 232 level)or RS485
Communicate Baudrate	RS232:1200~921600bps,typical baud rate:115200bps RS485:1200~115200bps,typical baud rate:9600bps
Interface Specification	2EDG3.81-6P
Image Local Download	SD card
Firmware local/remote upgrade	Insert SD card to upgrade locally / support user motherboard remote serial port to upgrade screen firmware
Image remote upgrade	Support users to remotely use their motherboard serial port to upgrade screen related picture projects, fonts, configuration files, etc.
Real-time clock(RTC)	Support clock,countdown, timer,etc.function)
Active Area of Displaying(AA)	L*W = 153.2mm*84.8mm

Product Dimension (L*W*H)	210.0mm*149.8mm*24mm
Development Software	VisualTFT®
Operating temperature	-20~+70℃
Storage Temperature	-30~+80℃
AV input	Not supported
Audio play	MP3 format (horn 4Ω2W, mono), sharing storage space with pictures. If the bitrate of the MP3 format is 128kbps, it takes up 0.92 MB/min of storage
Audio Connector Specification	PH2.0-2P
Video play	MP4 video format, sharing storage space with pictures. If a video file with a resolution of 800*600, a video bit rate of 3000Kbps, an audio bit rate of 166Kbps, and a frame rate of 25Hz, takes up 21.9MB/minute of storage
WIFI	Not support
Three Anti-paint Process	None(It is optional)

◆ Core Competitiveness	
Learning Circle	Familiar with the development environment in 30 minutes and complete the HMI design in 3 days
Program Debugging	The development software contains simulator. Engineers do not need to buy equipment and it can debug with Keil IDE directly.
Start-up Time	Operation upon power-on, no system loading time
Configuration Control	Various configuration controls are available, including button, text, pull-down menu, progressbar, slidingblock, instrument, animation, QR code, curve, data record and circular progress bar, Sprite slide control etc. function.
System keyboard	Built-in virtual numeric and character keyboard, support Chinese and English input method, customizable keyboard
Data record	Support data record controls content export to SD card
Layer Technique	The system has multiple built-in display layers to provide a higher switching speed
Multiple Languages	More than 10 languages of any country in the world can be preset, one-click to switch the required language, no need for multiple sets of UI
Logical Operation processing	The host computer has a built-in LUA script compiler, and users can customize various complex logical relationships and protocols on the screen to meet 99.9% of product function requirements of customers.
Remote Upgrade	Support remote serial port upgrade screen firmware, project files, designated pictures, configuration files and fonts, etc.
Life Cycle	Adopt traditional brand processors without supply shortage for years
◆ LCD	
Display Type	TFT LCD
Backlight Tube	LED
Brightness (cd/m ²)	180
Backlight Life (h)	>20,000
Contrast Ratio	200:1

Viewing(L/R/T/B)	55/55/55/30
------------------	-------------

◆ Touch Panel (Resistive /Capacitive is Optional)	
Touch type	Capacitive touch screen
Touch mode	Single-point and sliding touch
Capacitive screen light transmittance	Over 90%
Capacitive screen touch time	Theoretically capacitive screen touch time is infinite,the touch life is related to the working environment.
Capacitive cover customization	The "glass cover + capacitive touch" integrated fitting service can be customized according to the size of the user's drawing
Touch type	Resistive touch screen
Touch mode	Single-point and sliding touch
Resistive screen light transmittance	Over 80%
Resistive screen touch time	Single pixel point over 1 million times

◆ Customization Service	
Customization Fee	One-time order 1000PCS can partial exempt customized fee
Hardware Circuit	Can customize PCB size, circuit thickness, add user circuit, military-grade temperature display, etc.
Software Customization	Customize special instructions or controls according to user needs to reduce user development difficulty
UI design Service	Can provide picture art and product structure design services
Others	Customized on demand to meet all user needs

4. Reliability Test

A series of process reliability tests have been conducted before the mass production of all serial port screens of Dacai, including high-low temperature, ESD, group pulse, radiation, touch life and so on, so as to ensure the product quality, as Diagram 4-1 showed.

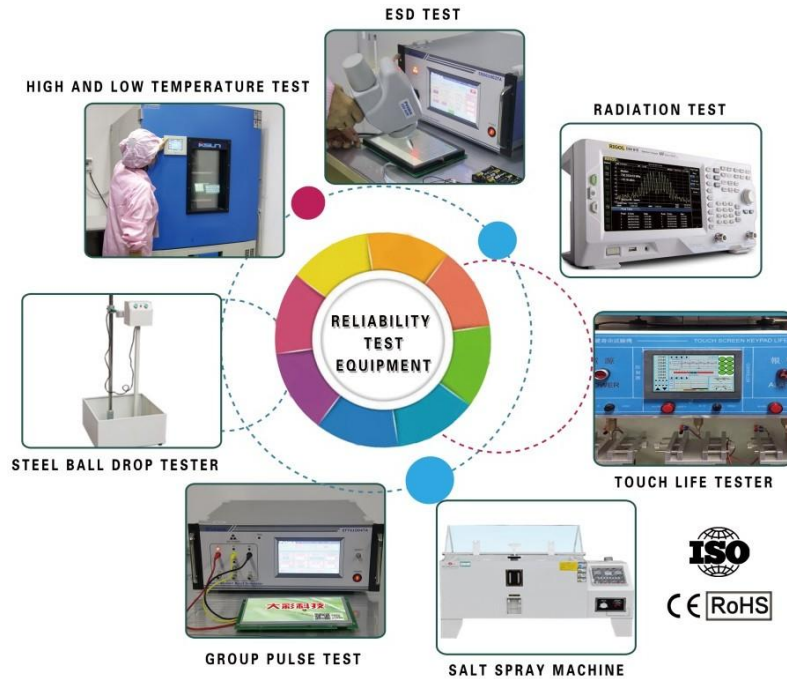

Diagram 4-1 Reliability test device

4.1 ESD Test

4.1.1 Executive Standard

Executive Standard

IEC 61000-4-2

4.1.2 Test Ambient

Test ambient temperature: 25°C

Test ambient humidity: 50%

Test process: Place the product on the test stand, lay down on the serial port screen buckle and the display area in order to make contact and air discharge as shown in Diagram 4-2. Observe whether if the screen have reset or restarted, or abnormal display.



Diagram 4-2 ESD Test

4.1.3 Test Data

Product model	Discharge type	Discharge value	Test result
DC10600KM070_1111_0T,6P38 vertical	Air	±18KV	No restart, no abnormal display, normal function
DC10600KM070_1111_0C,6P38 vertical	Air	±18KV	No restart, no abnormal display, normal function
DC10600KM070_1111_4T,6P38 vertical	Air	±18KV	No restart, no abnormal display, normal function
DC10600KM070_1111_4C,6P38 vertical	Air	±18KV	No restart, no abnormal display, normal function

Note: The current test tests are all product bareness tests. On the actual product assembly machine, keep the screen and the machine well grounded, or the surface of the touch panel is protected by PVC or cover plate, the ESD performance index of the whole machine will be higher.

4.2 High and low temperature aging test

4.2.1 Test Ambient

Test ambient temperature:-20~+70°C

Test ambient humidity:60%±3%RH

Test process: Place the product in the high and low temperature test box at an angle as shown in Diagram 4-3. Pass the 72H high temperature, low temperature and high and low temperature alternating change aging test. Observe whether the screen resets and restarts during the test and after the test. Abnormalities, abnormal functions, etc.



Diagram 4-3 High and low temperature aging test

4.2.2 Test Data

Product Model	Temperature	Humidity	Test Result
DC10600KM070_1111_0T,6P38 vertical	High temperature(70°C)	60%	No restart, no abnormal display, normal function
DC10600KM070_1111_0C,6P38 vertical	Low temperature(-20°C)	60%	No restart, no abnormal display, normal function
DC10600KM070_1111_4T,6P38 vertical	High and low temperature alternating (-20~70°C)	60%	No restart, no abnormal display, normal function

4.3 Group Pulse Test

4.3.1 Executive Standard

Executive Standard	IEC 61000-4-4
--------------------	---------------

4.3.2 Test Ambient

Test ambient temperature:25°C

Test ambient humidity:50%

Test process: Place the product on the test stand, and power the screen through the power supply after the pulse group generator is coupled to the pulse group, as shown inDiagram 4-4. During the

TEL: +49 5323 9988 0

Email: info@eckstein-gmbh.com

Betreiber: Eckstein GmbH

Hersteller: Guangzhou Dacai Optoelectronic Technology Co.,Ltd.

test, observe whether the screen resets, displays abnormally, or touches, abnormalities and other phenomena.



Diagram 4-4 Group pulse test

4.3.3 Test Data

Product Model	Test Standard			Test Result
DC10600KM070_1111_0T,6P38 vertical	International Standard 4			No restart, normal communication, normal function
DC10600KM070_1111_0C,6P38 vertical	Voltage(KV)	Frequency(KHZ)	Time(S)	
DC10600KM070_1111_4T,6P38 vertical	4.0	100	120	
DC10600KM070_1111_4C,6P38 vertical				

4.4 Radiation Test

4.4.1 Executive Standard

Executive Standard	EN55022 ClassB
--------------------	----------------

4.4.2 Test ambient

The radiation test laboratory environment is shown in Diagram 4-5.



Diagram 4-5 Radiation test

4.4.3 Test Data

1. Radiation test horizontal test data, as shown in Diagram 4-6.



Diagram 4-6 Horizontal direction of radiation test

2. Radiation test vertical test data, as shown in Diagram 4-7.

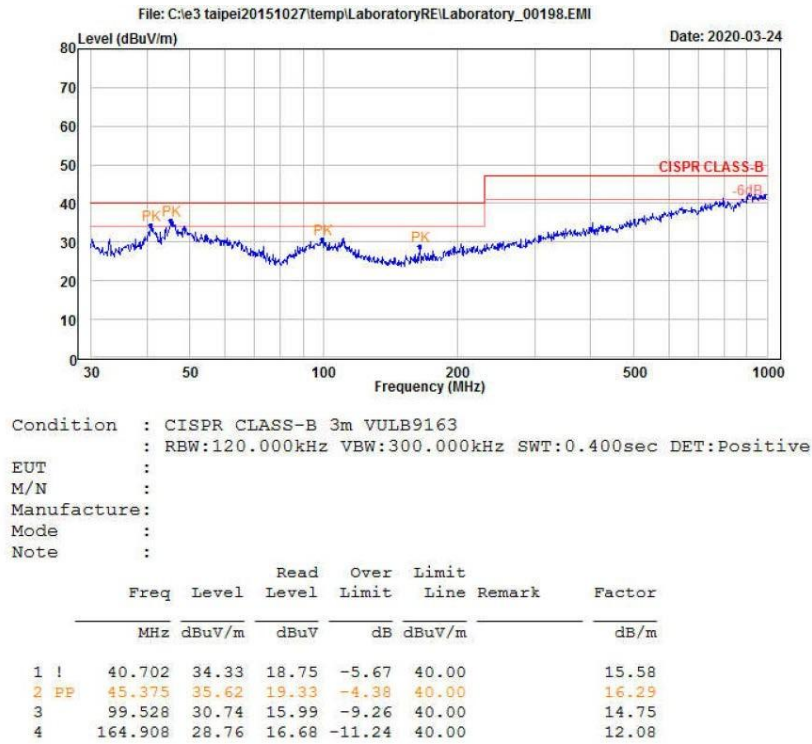
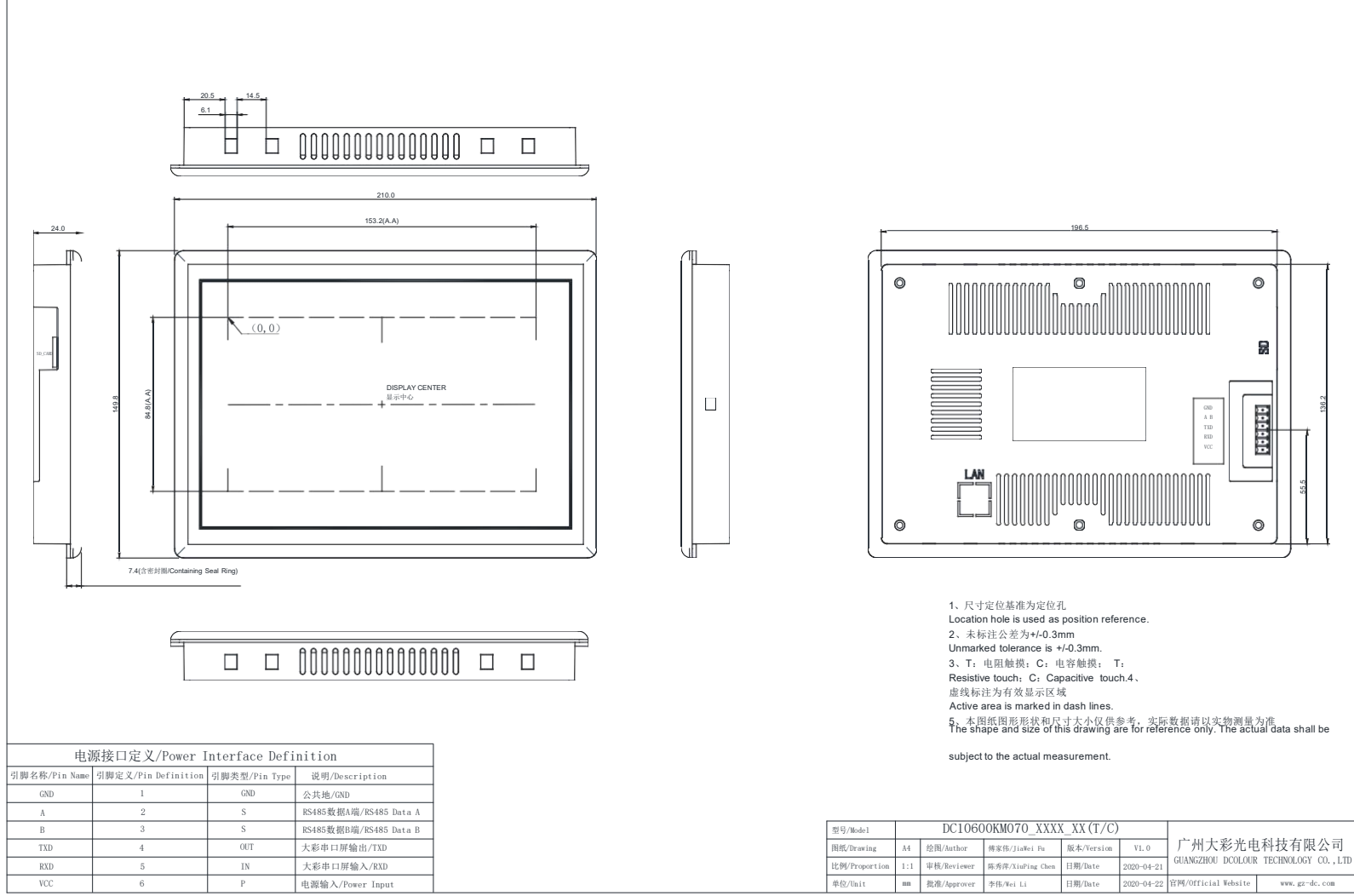

Diagram 4-7 Vertical direction of radiation test

5. Product demension



6. Model definition

The model definition is as below showed.

Table 6-1 model definition

DC10600KM070_XXXX_XX (T/C)

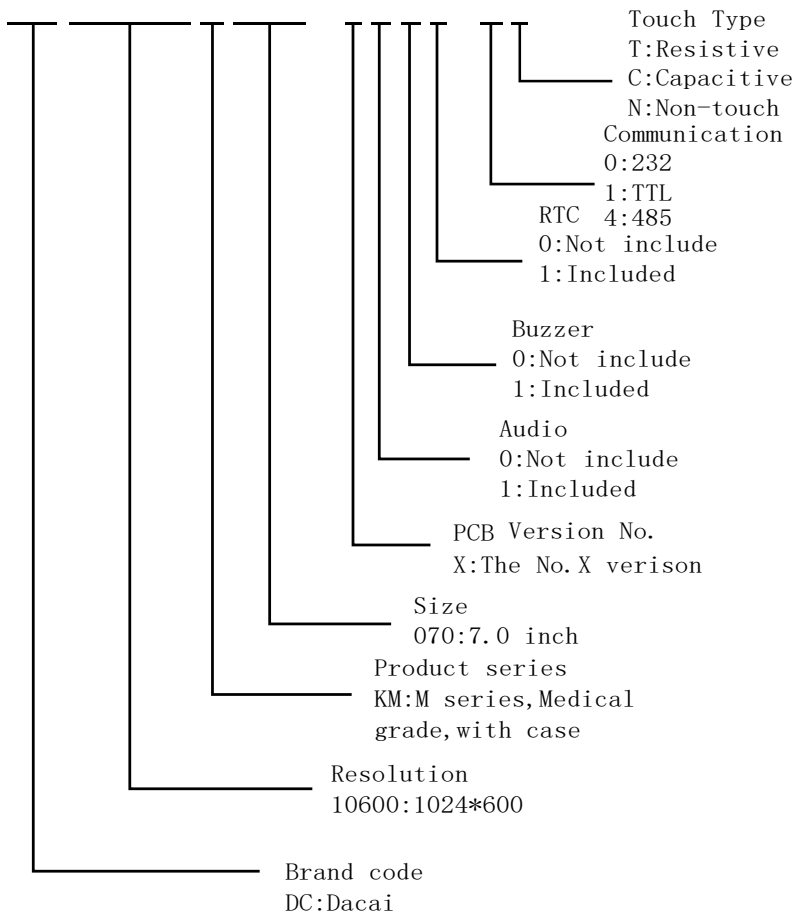

7. Switch RS232 & TTL electrical level

Almost all the products are support RS232 and TTL level exchange.As Diagram 7-1showed, when the dial switch SW1 is turned to 1, the serial port is at RS232 level; when the dial switch SW1 is turned to ON, the serial port is at TTL level. As shown in Diagram 7-2, the switch can be toggled from the opening of the case..

Note:TTL electrical level support 3.3V CMOS and 5V TTL

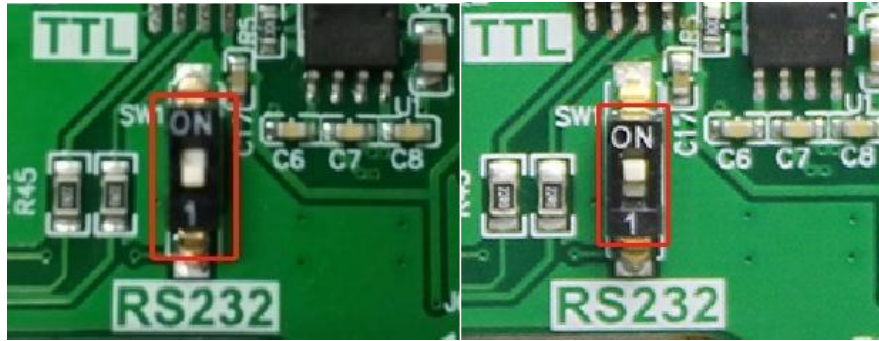

Diagram 7-1 RS232/TTL level



Diagram 7-2 Level switch

8. Protocol Configuration

Most of the serial screens launched by Guangzhou Dacai Optoelectronic Technology Co., Ltd. default to the Dacai configuration instruction set. Users can configure and run MODBUS RTU, XGUS and other protocols through the host computer.

Open the VisualTFT host computer software, click the menu bar [Tool] → [Protocol and Variable Settings], as shown in Diagram 8-1, enter the protocol configuration interface, users can choose to enable the corresponding protocol according to their own needs, as shown in Diagram 8-2

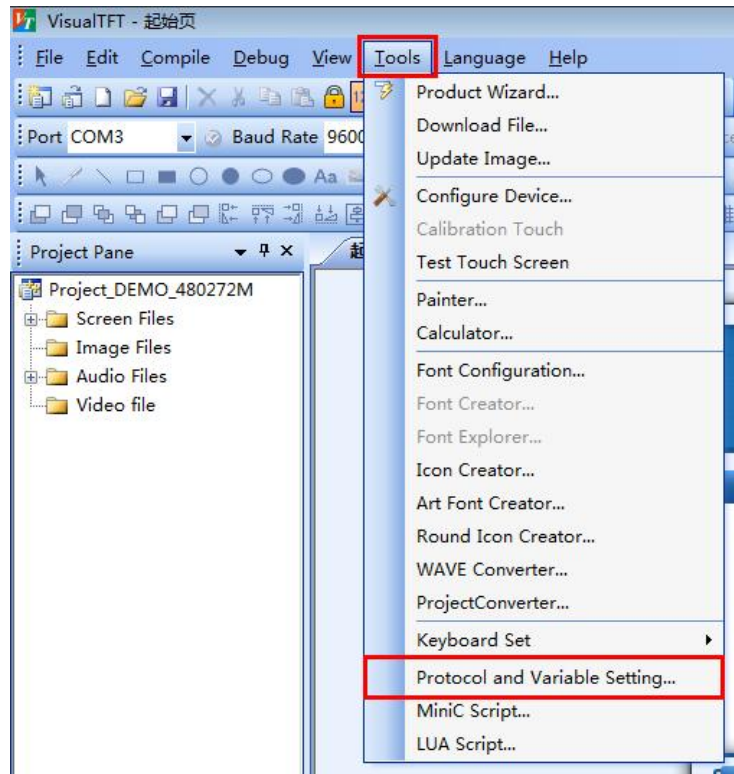

Diagram 8-1 Protocol and variable settings

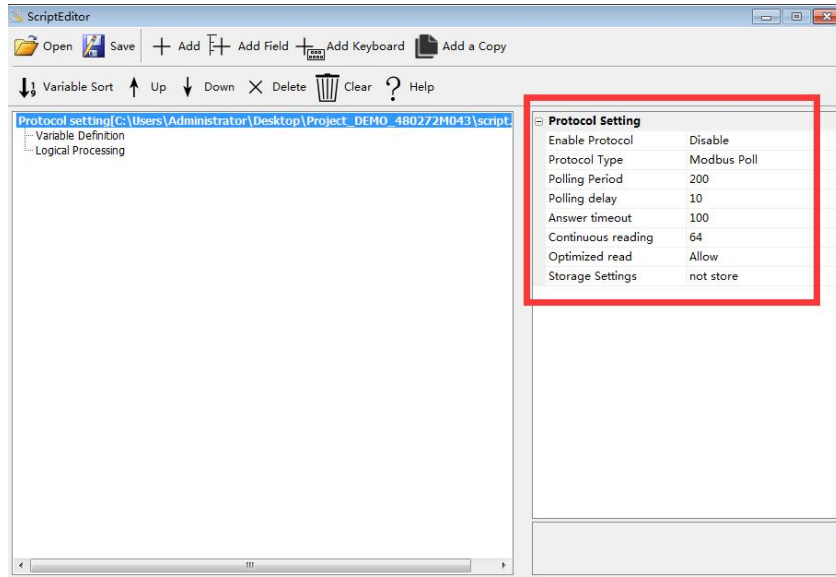

Diagram 8-2 Protocol configuration

9. LUA Script Configuration

The serial screens of F series, M series and W series launched by Guangzhou Dacai Optoelectronic Technology Co., Ltd. all support LUA language scripts. The serial port screen provides numerous LUA scripting API and callback interface. The user can directly set and obtain the running status of all configuration controls by calling the API interface. Combined with the logic processing, the screen can complete predetermined actions without external MCU participation, which is reduce data communication between MCU and screen.

LUA is a lightweight scripting language, the grammar logic is simpler than C language, developers can directly get started. The LUA language comes with a well-functioning mathematical function library, string processing, JSON and other libraries. It has function support for common mathematical operations, such as square root, sine and cosine, and absolute values. Due to the high frequency of the screen itself, complex algorithms After all are handed over to the screen for processing, the execution overhead of the user MCU is greatly reduced.

LUA tutorials can be accessed from third-party websites: <https://www.runoob.com/lua/lua-tutorial.html>.

LUA script of the program written by VisualTFT software, click [Tool] → [LUA Script Programming] in the menu bar to open it, as shown in Diagram 9-1, and enter the LUA script writing interface as shown in Diagram 9-2

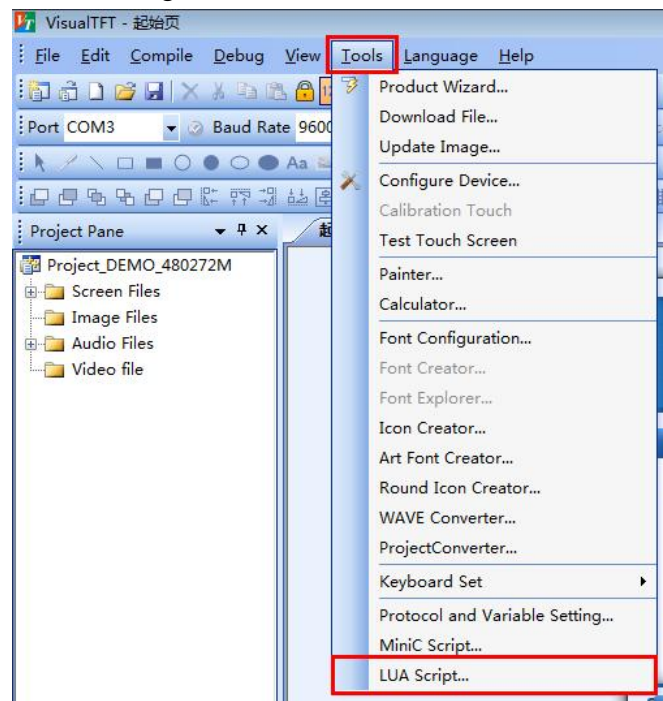

Diagram 9-1 LUA Script programming

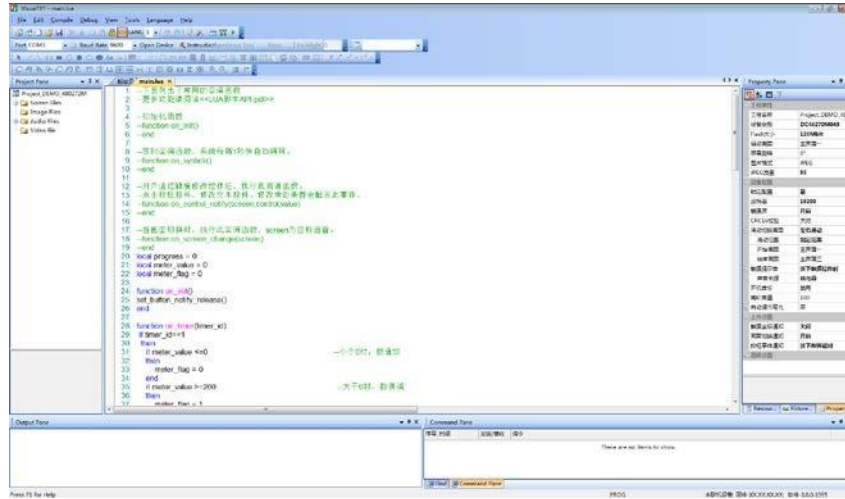

Diagram 9-2 Lua script programming

10. Package and Size

Single Product Weight					
Net weight(KG)	0.44				
Package Standard and Total Weight					
Packing Box Model	Packing box size(L*W*H,unit ,mm)	Layer	Quantity(PCS)/Layer	Total quantity(pcs)	Total weight (KG)
No.1 Packing box	478*340*275	1	10	10	5.93
No.2 Packing box	616*478*275	1	20	20	11.55

Note: The total weight does not include the weight of accessories; the above weight information is the estimated weight for reference only, the actual weight is subject to actual.

11. Product Structure

The industrial serial port screen launched by Guangzhou Dacai Optoelectronic Technology Co., Ltd. is a serial display terminal that integrates TFT display driver, picture storage, GUI operation, audio playback and various configuration controls. The user MCU only needs to send and receive the corresponding serial port commands to easily display text, pictures and curves.

The M series serial port screen processor uses a 32-bit 400M SOC processor, which integrates functions such as SDR memory and JPEG image decoding. The system structure is shown in Diagram 11-1

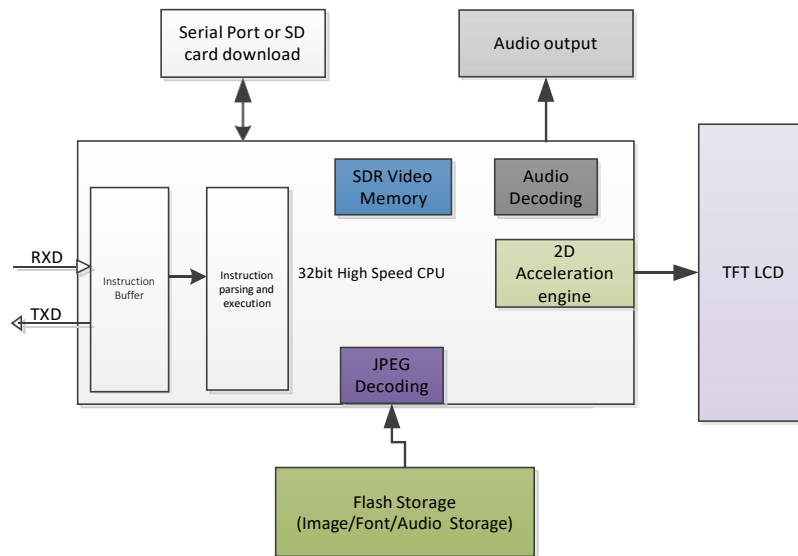

Diagram 11-1 M series product internal structure diagram of serial screen

The main advantages of choosing a high-performance 32-bit dual-core processor structure are:

1. Dedicated 32-bit 400M SOC processor optimized for picture display, with 2D acceleration engine, JPEG picture hardware decoding, so that the display can cooperate with various special effects, and the display effect is smooth and gorgeous.
2. No operating system, 24 * 365h hours of continuous power can work reliably, no garbage redundant files.

12. Development Software

VisualTFT is a serial port screen development and debugging software independently developed by Guangzhou Dacai. It integrates the first exclusive "virtual serial port screen" simulation emulator in China, is free for life. After the user creates a new project, import the designed UI picture, and then configure the buttons and other controls in each screen. After the simulation is correct, finally download the entire project to the serial port screen. The software interface is shown in Diagram 12-1.



Diagram 12-1 VisualTFT Main interface

Any Dacai user can complete the complex human-computer interaction design within 30 Minutes by only 3 steps:

1. Prepare art design materials:

Arrange UI designers to design the images required for products such as start-up image, text background, button icon and prompt box.

2. Conduct image editing, scripting, control configuration and image downloading with VisualTFT software:

First of all, using the supporting host computer VisualTFT software, then typeset interface and configure controls of the pre-designed artwork pictures, run the "virtual serial port screen" for simulation, and finally the entire project can be completed download through SD / UART (depending on the hardware configuration of different models) to the internal memory of the serial port screen. The PC software will assign a unique ID number to each screen, picture and control in the project. Users can also write the required logic control and algorithms through the script editor embedded in the host computer to reduce the communication frequency between the screen and the motherboard.

3. User's single-chip micro computer monitors and sends the corresponding serial port instructions to control the image display:

After the project is downloaded to the screen and when a button is pressed on the image, the user's MCU serial port will receive the button ID information or coordinate value uploaded by the screen. By parsing the ID number, the user can get the image position and function attributes of the current button. In this way, relevant peripheral device actions or image updating and display can be

controlled.

For non-touch products, the user MCU does not need to monitor the information uploaded by the button ID, but only needs to send relevant commands to switch screens and display text and pictures.

12.1 What is visual serial interface screen

‘Virtual Serial Screen’ is the first serial screen emulator in China, which is developed by Guangzhou Dacai Optoelectronic Technology Co., Ltd.. After the user has created the program, corrected the configuration and compilation, then you can run it to test whether the interface design is correct. The simulation result is exactly the same as the real serial screen. Even if the user didn't purchase hardware, and directly connects to the ‘virtual serial port’ through their own MCU and RS232 serial port, they can still communicate with each other. Click button will upload the button control ID or coordinate information immediately, as Diagram 12-2 shows. Once the ‘virtual serial screen’ is debugged, the real hardware can be downloaded directly without any debugging.



Diagram 12-2 Onlinedebugging of serial port of user's single-chip microcomputer and virtual serial port screen

12.2 The binding debugging of Keli and Virtual serial port screen

In order to further improve the development efficiency, users can also use the KEIL development environment to bind DEBUG with the ‘virtual serial screen’. When the program is single-step debugging, all running results can be presented on the ‘virtual serial screen’, which greatly saves engineering development time. As Diagram 12-3 shows. Once the engineering interface changes, the user no longer needs to download the image again to the serial screen, all the pre-evaluation of the project can be based on the PC side to complete.

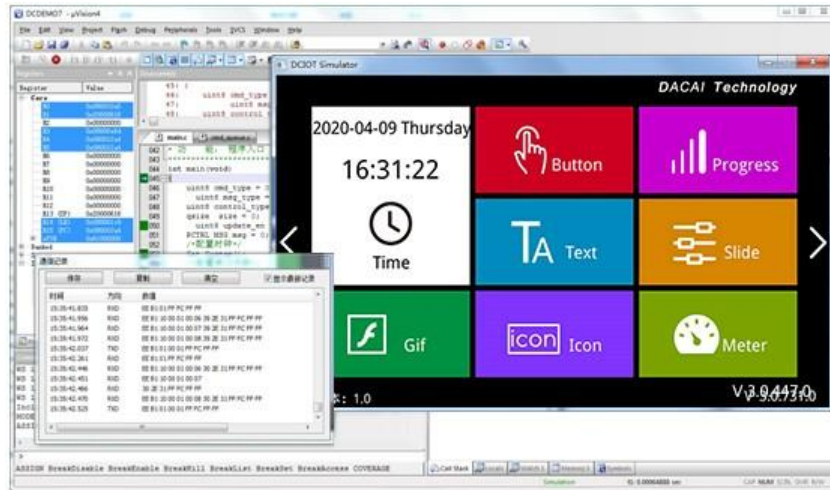

Diagram 12-3 Keil develop environment and binding debug of virtual serial port screen

Note: The debugging of the virtual serial port screen requires keil software support. During the Debug process, enter dirvreg in the command serial port, and SxIN needs to be listed (depending on the microcontroller, x may represent 0, 1, 2), if it is listed, keil has already The serial port of the single-chip microcomputer is virtualized to the register so that it can be used.

13. Development File

In order to complete product development faster,beginners can log in to the official website:www.gz-dc.com,enter the ‘data download’column,download the corresponding ‘development kit’ and ‘Dacai configuration instruction set’,‘LUA tutorial application’and other documents.

14. Disclaimer

This document provides information about the products of Guangzhou Dacai Optoelectronic Technology Co., Ltd. (hereinafter referred to as Dacai Technology), in accelerating the progress of product development. Any routines, technical documents, CAD drawings and other information and information provided during the service process or other channels are only for reference, the customer has the right not to use or modify the reference by itself. The company does not provide any guarantee of completeness, reliability, etc. If the customer uses special, accidental or indirect losses caused by any reason during the use of the company, the company we do not assume any responsibility. Products of Dacai cannot be used as the sole control device for military, medical, life-saving or life-sustaining applications.

This document does not grant any license to intellectual property and does not grant any intellectual property license, express or implied, or by prohibition of speaking or otherwise. Dacai assumes no responsibility other than the liability stated by Dacai in the terms and conditions of sale of its products. Furthermore, Dacai makes no warranties, express or implied, regarding the sale or use of Dacai Technology products, including the suitability for the specific use of the products, their merchantability or infringement of any patents, copyrights or other intellectual property rights, no guarantee. Dacai Technology may make changes to product specifications and product descriptions at any time without notice.